



### FEATURES

**1. Power switches with an electromagnetic reset function which meet the need for energy savings in equipment and for safety.**

Applications for these switches include promoting energy savings in equipment (by reducing power consumption when OA equipment is in standby mode, for example), preventing fires caused by overheating of a heater inside equipment, preventing electrical leaks, and automatically turning off the power if the unit tips over or is shaken. These switches feature a built-in electromagnetic reset function that shuts off the main power supply in response to a signal that is received from an external sensor.

**2. Improved feel of switch operation. These switches provide the same comfortable operation of our conventional AJ8 switches.**

Comparison of force through operating stroke

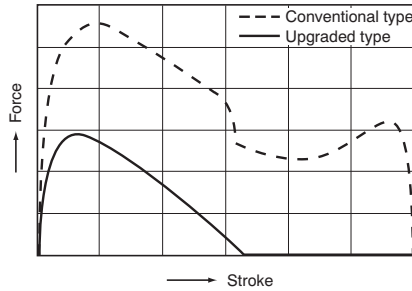

**3. CT terminals adopted for coil terminals**

These switches can be used with AMP's CT connectors, which are widely used for wiring connections in OA equipment, making it possible to achieve greater efficiency in wiring work. Receptacle socket for AMP's CT connector

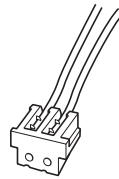

**4. Prolonged electrical service life.**

Coil operation provides an electrical life of at least 50,000 switching operations.

**5. Assures excellent ability to withstand inrush current when used to turn a power supply on/off.**

The switch uses our own proprietary mechanism that provides an excellent ability to withstand inrush current.

Inrush current rating (IEC61058-1): 160A (normally 16A at 125V AC), 10,000 times.

**6. Approved under major international safety standards.**

UL/C-UL, TÜV and SEMKO approved.

### OPERATING PRINCIPLE

- Manual operation is a repetition of (A) and (B). This operation is independent of the electromagnetic reset function.
- The reset mechanism operates only when an electromagnetic reset has occurred. (C)

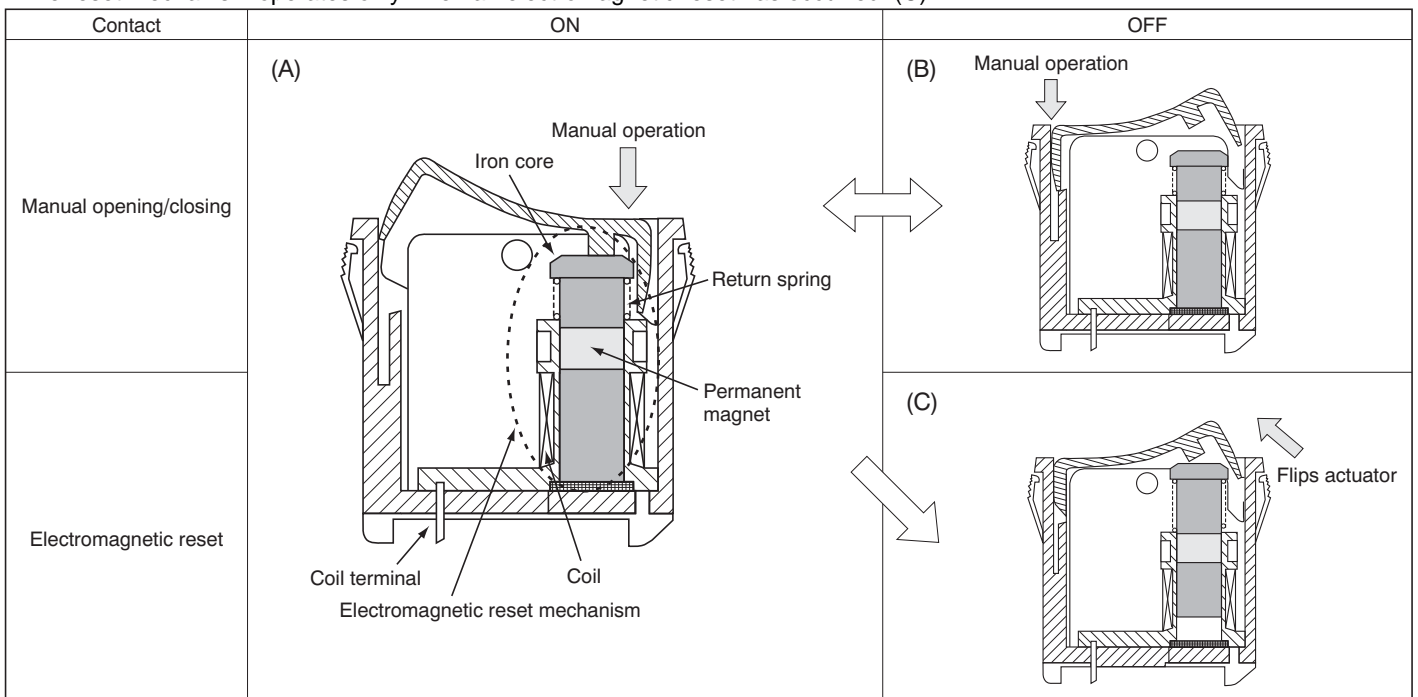

## ORDERING INFORMATION

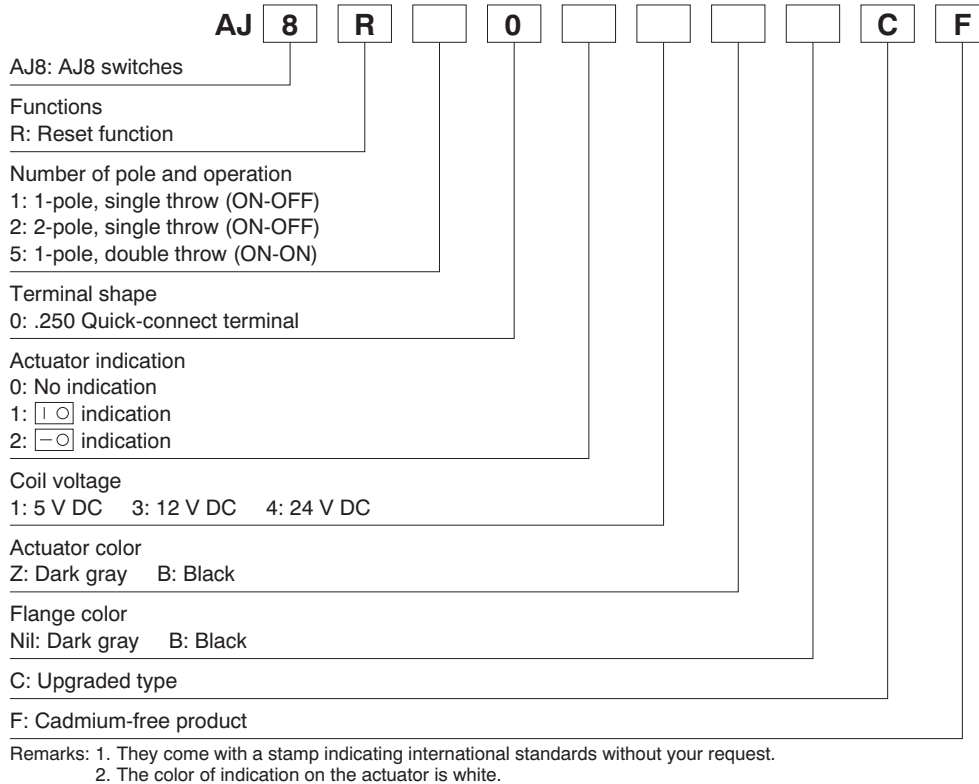

## PRODUCT TYPES

Remarks: Standard actuator color is dark gray and black.  
To order switches with a black actuator, replace the letter "Z" with "B" in the product numbers shown below when ordering.  
(ex.) AJ8R1001ZC (actuator color: dark gray flange color: dark gray)  
→ AJ8R1001BC (actuator color: black flange color: dark gray)

### 1. Without indication on actuators (actuator color: dark gray)

Poles	Operation type	Coil voltage	Part no.	
			Flange color: dark gray	Flange color: black
1-pole	Single throw (ON-OFF)	5V DC	AJ8R1001ZCF	AJ8R1001ZBCF
		12V DC	AJ8R1003ZCF	AJ8R1003ZBCF
		24V DC	AJ8R1004ZCF	AJ8R1004ZBCF
	Double throw (ON-ON)	5V DC	AJ8R5001ZCF	AJ8R5001ZBCF
		12V DC	AJ8R5003ZCF	AJ8R5003ZBCF
		24V DC	AJ8R5004ZCF	AJ8R5004ZBCF
2-pole	Single throw (ON-OFF)	5V DC	AJ8R2001ZCF	AJ8R2001ZBCF
		12V DC	AJ8R2003ZCF	AJ8R2003ZBCF
		24V DC	AJ8R2004ZCF	AJ8R2004ZBCF

### 2. With indication on actuator

#### 1) With I O indication (actuator color: dark gray)

Poles	Operation type	Coil voltage	Part no.	
			Flange color: dark gray	Flange color: black
1-pole	Single throw (ON-OFF)	5V DC	AJ8R1011ZCF	AJ8R1011ZBCF
		12V DC	AJ8R1013ZCF	AJ8R1013ZBCF
		24V DC	AJ8R1014ZCF	AJ8R1014ZBCF
	Double throw (ON-ON)	5V DC	AJ8R5011ZCF	AJ8R5011ZBCF
		12V DC	AJ8R5013ZCF	AJ8R5013ZBCF
		24V DC	AJ8R5014ZCF	AJ8R5014ZBCF
2-pole	Single throw (ON-OFF)	5V DC	AJ8R2011ZCF	AJ8R2011ZBCF
		12V DC	AJ8R2013ZCF	AJ8R2013ZBCF
		24V DC	AJ8R2014ZCF	AJ8R2014ZBCF

## 2) With I O indication (actuator color: dark gray)

Poles	Operation type	Coil voltage	Part no.	
			Flange color: dark gray	Flange color: black
1-pole	Single throw (ON-OFF)	5V DC	AJ8R1021ZCF	AJ8R1021ZBCF
		12V DC	AJ8R1023ZCF	AJ8R1023ZBCF
		24V DC	AJ8R1024ZCF	AJ8R1024ZBCF
	Double throw (ON-ON)	5V DC	AJ8R5021ZCF	AJ8R5021ZBCF
		12V DC	AJ8R5023ZCF	AJ8R5023ZBCF
		24V DC	AJ8R5024ZCF	AJ8R5024ZBCF
2-pole	Single throw (ON-OFF)	5V DC	AJ8R2021ZCF	AJ8R2021ZBCF
		12V DC	AJ8R2023ZCF	AJ8R2023ZBCF
		24V DC	AJ8R2024ZCF	AJ8R2024ZBCF

## SPECIFICATIONS

### 1. Contact rating

Voltage	Resistive load (power factor = 1)	Motor load (EN61058-1) (power factor = 0.6)	Inrush load
125V AC	16A	—	100A (8.3ms)
250V AC	10A	4A	—

Remark: The motor load is in accordance with EN61058-1. Inrush current can be switched up to the value of 6 times the indicated rating.

### 2. Coil rating

Nominal Voltage *(max. 10 sec)	Drop-out voltage (at 20°C)	Nominal operating current [±10%] (at 20°C)	Coil resistance [±10%] (at 20°C)	Maximum voltage (max. 1 s)
5V DC	Max.4.5V Min.0.5V	725mA	6.9Ω	5.5V
12V DC	Max.10.8V Min.1.2V	300mA	40Ω	13.2V
24V DC	Max.21.6V Min.2.4V	150mA	160Ω	26.4V

Remark: If the rated voltage is applied to the coil for more than ten seconds or the maximum voltage is applied for more than one second, coil performance will deteriorate. Please apply more than 90% of coil voltage to reset the switch.

### 3. Characteristics

Electrical life	Manual operation	Min.10 <sup>4</sup> (at 7 cpm.,at rated load)
	Coil operation	Min.10 <sup>3</sup> (at 7 cpm.,at rated load), Min.5×10 <sup>4</sup> (at 7 cpm. 5A 125V AC)
Mechanical life		Min.5×10 <sup>4</sup> (at 20 cpm.)
Contact resistance (initial)		Max. 100mΩ (by voltage drop at 1A, 2 to 4V DC)
Insulation resistance (initial)		Min. 100MΩ (at 500V DC measured by insulation resistive meter)
Dielectric strength (initial)	Between contacts	2,000 Vrms (detection current: 10mA)
	Between coil and contact	4,000 Vrms (detection current: 10mA)
Ambient temperature		0°C to +60°C (not freezing below 0°C)
Vibration resistance		10 to 55 Hz at single amplitude of 0.75mm, 2 hours each in X, Y and Z directions, (contact opening max. 1ms)
Shock resistance	Functional	Min.294m/s <sup>2</sup> {30G} (contact opening max. 1ms)
	Destructive	Min.980m/s <sup>2</sup> {100G}
Terminal strength		.250 Quick-connect terminal: Min. 98N{10kgf}/min. (pull & push direction)
Actuator strength		39.2N{4kgf} for 1min. operating direction
Contact release time		Max. 100ms (at rated voltage)
Operating force (initial) * Reference value		4.9N or less (max. 500gf or less) Setting force after reset has been released: max. 6.86N or less (max. 700gf or less)
Flame retardancy		UL94V-0
Tracking resistance		Min. 175
Unit weight		1-pole, single throw: Approx. 17g; 1-pole, double throw: Approx. 19g; 2-pole, single throw: Approx. 20g
Contact material		AgSnO <sub>2</sub> alloy

Remark: Test conditions are in accordance with EN61058-1, UL1054 and JIS C 6571.

**DIMENSIONS**

Interested in CAD data? You can obtain CAD data for all products with a **CAD Data** mark from your local Panasonic Electric Works representative.

mm General tolerance: ±0.5

**2-pole, single throw (ON-OFF)**

**CAD Data**

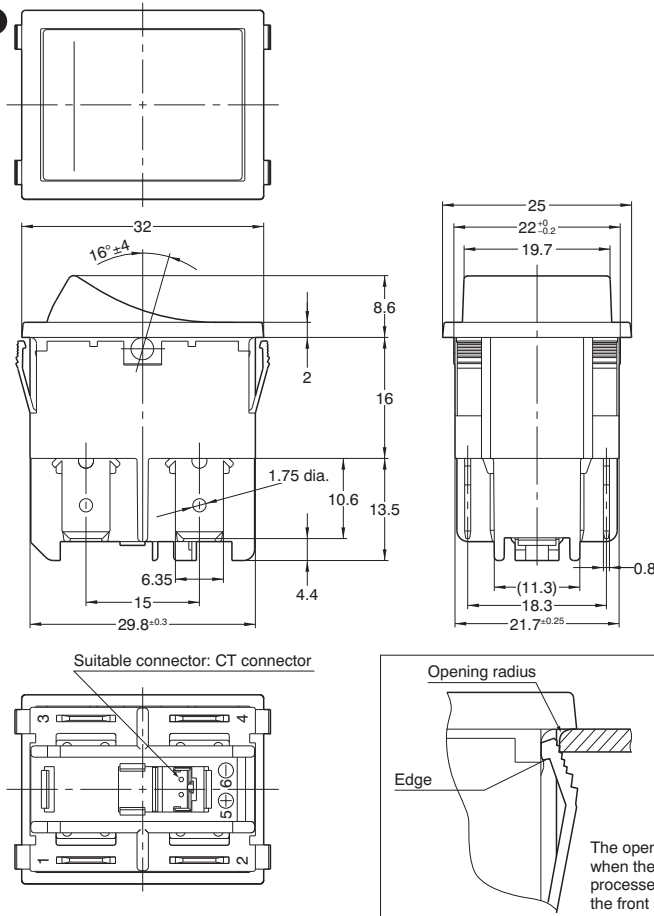

Wiring diagram (bottom view)  
1-pole, single throw (ON-OFF)

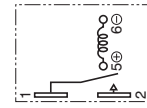

ON (set): 1-2 closed

1-pole, double throw (ON-ON)

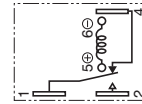

Reset: 1-4 closed  
Set: 1-2 closed

2-pole, single throw (ON-OFF)

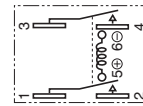

ON (set): 1-2 closed  
3-4 closed

Diagram of recommended locations for panel mounting holes

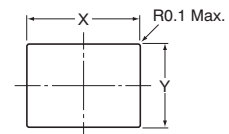

Panel thickness	X	Y
1 to less than 1.8	30.4 <sup>+0</sup> <sub>-0.1</sub>	22.0 <sup>-0.1</sup> <sub>-0</sub>
1.8 to 2.3	31.1 <sup>+0</sup> <sub>-0.1</sub>	22.0 <sup>-0.1</sup> <sub>-0</sub>

Remark: Contact us if you are considering using a panel of other than the recommended size and shape.

- Remarks: 1. The external dimensions and mounting dimensions for the 1-pole, single throw type and the 1-pole, double throw type are the same as those for the 2-pole, single throw type indicated above.  
2. The figures show the 2-pole, single throw (ON-OFF) type as an example. The contact terminals are 1, 2, 3, and 4. In the case of the 1-pole, single throw (ON-OFF) type, the contact terminals are 1 and 2. In the case of the 1-pole, double throw (ON-ON) type, the contact terminals are 1, 2, and 4. There are no other terminals. Refer to the internal wiring diagram.  
3. The coil is a polarized coil; coil terminal 5 is positive and coil terminal 6 is negative.

## NOTES

### 1. Operating voltage application time

If the rated voltage is applied to the coil for more than 10 seconds or the maximum voltage is applied for more than 1 second, coil performance may deteriorate.

### 2. The shape of the mounting panel should be as recommended in the dimensions diagram.

Contact us if you are considering using a panel of other than the recommended size and shape.

### 3. The mounting panel should be made of SPCC. If a different material is used, its adhesion to the switch unit may not be as strong. Check this on site if necessary.

### 4. Note that the actuator could pop out of the switch housing if 19.6N (2kgf) or more of force is applied to the side of the actuator.

### 5. Regarding fastening lead wires to terminals

(1) When connecting the .250 Quick-connect terminals, use a .250 receptacle and insert the terminals straight in.

If you insert them at an angle, the terminals could catch on the opening and will require greater insertion force.

(2) The coil terminals have specific polarities. Make sure you connect them correctly.

(3) Use a receptacle that is compliant with JIS C 2809.

In addition, there is some deviation regarding the insertion force depending on the model used from different manufacturers, so the insertion force should be checked under realistic conditions.

(4) Use AMP's CT connector for the coil terminals.

### 6. Because special receptacle terminals are used for the contact terminals and the common terminals, do not attempt to solder them. Doing so could melt plastic components and otherwise harm the performance of the switch

### 7. The terminals should be connected in such a way that they are not under constant stress from the connecting wires.

### 8. Take care not to drop the product as it may impair performance.

### 9. Resistance to chemicals

To clean the switch unit, use a neutral detergent diluted with water.

Do not use acidic or alkaline solvents as they may damage the switch.

Furthermore, be careful not to get any of the detergent solution inside of the switch while cleaning it.

**10. This product is not hermetically sealed, so its performance could deteriorate under certain ambient conditions. Avoid using and storing these switches in a location where they will be exposed to corrosive gases, silicon, or high dust levels, all of which can have an adverse effect on the contacts. In addition, because these switches contain permanent magnets, avoid using and storing these switches in a location where metallic dust, etc., is present.**

**11. When these switches are used with weak currents of 500mA or less, a layer of material on the surface of the contacts may cause contact instability. Check and evaluate this possibility before using these switches under such conditions.**

**12. When using an ON-OFF type switch with no (I O) indication on the actuator, the "OFF" position should be indicated on the set in which the switch is installed.**

**13. To assure reliability, check the switch under actual loading conditions. Avoid any situation that may adversely affect switching performance.**

## COIL TERMINAL CONNECTOR

Because CT terminals are used for the coil terminals, AMP's CT connector can be used.

Remark: We do not sell this type of connector. Questions concerning this connector should be directed to the manufacturer.

### AMP's CT connector

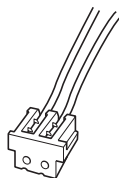

receptacle socket

### Pressure welding type:

173977-2: for AWG26, 28

2-179694-2: for AWG24

### Crimping type:

179228-2