

Amplifier built-in type

GX series

Inductive proximity sensors

Wide variation

- Ultra small sensor**
 The smallest $\phi 3.8\text{mm}$ size (GX-3S and GX-3SB) in the industry enabling installation anywhere.
- Long-distance sensing**
 The non-flush (GX-18H and units suffixed by "ML") type is the same size as the flush type. However, non-flush type has attained a sensing distance twice that of the flush type, thereby enabling to respond distance variation very easily.
- Operation indicator provided**
 All types of sensors are equipped with operation indicators for easy adjustment and maintenance.
- Notable flexibility**
 With its wide voltage range, multi-purpose open-collector output, sufficient output capacity and high-performance protection IP67, GX series inductive proximity sensors provide notable flexibility.

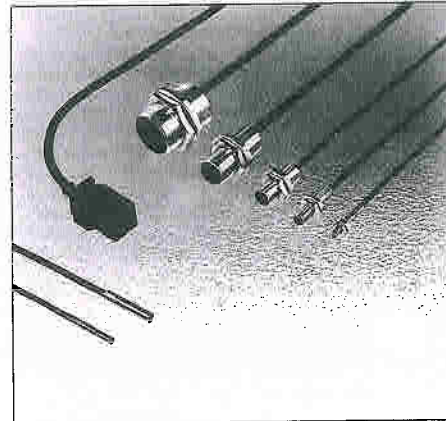

APPLICATIONS

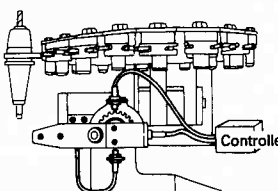
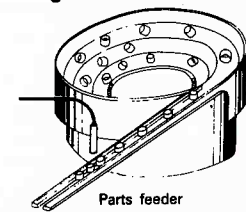
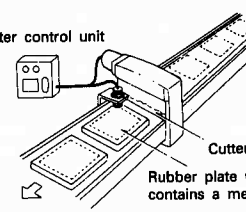
<p>Positioning of revolving shaft</p>  <ul style="list-style-type: none"> • For positioning of machining tools • Also, effective as a pulse generator 	<p>Counting of screws</p>  <ul style="list-style-type: none"> • Counting of products supplied on parts feeder 	<p>Detection of enclosed metals</p>  <ul style="list-style-type: none"> • Presence/absence detection or positioning of metals which are housed in a resin.
---	---	--

OPTIONAL COMPONENTS (available by separate order)

Article	Unit No.	Applicable units
Head cover	MS-H12	GX-12M(B) only
	MS-H18	GX-18M(B) only
	MS-H30	GX-30M(B) only

Head cover

The head cover keeps the sensing face away from flash sputter, etc.



■ SPECIFICATIONS (flush type)*1

Classification	Unthreaded								Threaded							
	Item	Unit No.	GX-3S	GX-3SB	GX-5S	GX-5SB	GX-5M	GX-5MB	GX-8M	GX-8MB	GX-12M	GX-12MB	GX-18M	GX-18MB	GX-30M	GX-30MB
Rated sensing distance (*2)			0.8 mm ± 15%		1 mm ± 15%		0.8 mm ± 15%		1 mm ± 15%		2 mm ± 10%		5 mm ± 10%		10 mm ± 10%	
Setting distance (*3)			0 to 0.6mm		0 to 0.8mm		0 to 0.6mm		0 to 0.8mm		0 to 1.6mm		0 to 4mm		0 to 8mm	
Standard target			Iron plate 5×5×1 mm		Iron plate 6×6×1 mm		Iron plate 5×5×1 mm		Iron plate 8×8×1 mm		Iron plate 12×12×1 mm		Iron plate 18×18×1 mm		Iron plate 30×30×1 mm	
Hysteresis			Less than 15% of the rated sensing distance													
Repeat accuracy			Less than 20μm		Less than 8μm		Less than 20μm		Less than 8μm		Less than 16μm		Less than 40μm		Less than 80μm	
Power source			12 to 24V DC ± 10% Ripple P-P: Less than 10%		10 to 30V DC Ripple P-P: Less than 10%		12 to 24V DC ± 10% Ripple P-P: Less than 10%		10 to 30V DC Ripple P-P: Less than 10%							
Consumption			Less than 15mA													
Output			NPN transistor-open collector ● Sink current: Max. 50mA ● Applied voltage: Less than 30V DC ● Residual voltage: Less than 0.4V DC at 50mA sink current		NPN transistor-open collector ● Sink current: Max. 200mA ● Applied voltage: less than 30V DC ● Residual voltage: less than 1.5V at 200mA sink current Less than 0.4V at 50mA sink current		NPN transistor-open collector ● Sink current: Max. 50mA ● Applied voltage: Less than 30V DC ● Residual voltage: Less than 0.4V DC at 50mA sink current		NPN transistor-open collector ● Sink current: Max. 200mA ● Applied voltage: Less than 30V DC ● Residual voltage: Less than 1.5V at 200mA sink current Less than 0.4V at 50mA sink current							
Output operation			Approach-ON	Leave-ON	Approach-ON	Leave-ON	Approach-ON	Leave-ON	Approach-ON	Leave-ON	Approach-ON	Leave-ON	Approach-ON	Leave-ON	Approach-ON	Leave-ON
Short-circuit protection			Included													
Max. response frequency			1,000Hz		1,500Hz		1,000Hz		800Hz		350Hz		100Hz			
Operation indicator			Red LED (illuminates when output is ON state)													
Protection			IP 67													
Ambient temperature			-25 to +70°C / -25 to +80°C (storage)		-25 to +80°C		-25 to +70°C / -25 to +80°C (storage)		-25 to +80°C							
Ambient humidity			35 to 95%RH													
Dielectric			500V AC applied between live parts and enclosure for 1min.													
Insulation			More than 5MΩ applied between live parts and enclosure at 250V DC		More than 50MΩ applied between live parts and enclosure at 500V DC		More than 5MΩ applied between live parts and enclosure at 250V DC		More than 50MΩ applied between live parts and enclosure at 500V DC							
Vibration			1.5mm amplitude at frequency of 10 to 55 Hz in each of X, Y and Z directions for 2 hours each in power OFF state													
Shock			200m/s ² (approx. 20G) impulse in each of X, Y and Z directions for 10 times each in power OFF state		300m/s ² (approx. 30G) impulse in each of X, Y and Z directions for 10 times each in power OFF state		200m/s ² (approx. 20G) impulse in each of X, Y and Z directions for 10 times each in power OFF state		300m/s ² (approx. 30G) impulse in each of X, Y and Z directions for 10 times each in power OFF state							
Temperature			Less than ± 20% of sensing distance at 20°C in -25 to +70°C temperature range		Less than ± 15% of sensing distance at 20°C in -25 to +70°C temperature range		Less than ± 20% of sensing distance at 20°C in -25 to +70°C temperature range		Less than +15% and -10% of sensing distance at 20°C in -25 to +70°C temperature range		Less than ± 10% of sensing distance at 20°C in -25 to +70°C temperature range					
Voltage			Less than ± 2% at ± 10% fluctuation of power source		Less than ± 2.5% at ± 15% fluctuation of power source		Less than ± 2% at ± 10% fluctuation of power source		Less than ± 2.5% at ± 15% fluctuation of power source							
Enclosure			Metal parts: Stainless (SUS304) Plastic parts: TPX		Metal parts: Brass (nickel plated) Plastic parts: 66 nylon		Metal parts: Brass (nickel plated) Plastic parts: TPX		Metal parts: Brass (nickel plated) Plastic parts: 66 nylon							
Cable			0.08mm ² x 3 cores with 3m of oil, heat and cold resistant cable		0.14mm ² x 3 cores with 3m of oil, heat and cold resistant cable		0.08mm ² x 3 cores with 3m of oil, heat and cold resistant cable		0.14mm ² x 3 cores with 3m of oil, heat and cold resistant cable				0.3mm ² x 3 cores with 3m of oil, heat and cold resistant cable			
Cable extension			Extensible up to 100m using more than 0.3mm ² cable													
Weight (*3)			Approx. 30g		Approx. 55g		Approx. 30g		Approx. 60g		Approx. 70g		Approx. 180g		Approx. 260g	
Accessories			MS-SS3 (mounting bracket): 1pc., MS-SS3-2 (fixture, type C): 1pc.		MS-SS5 (mounting bracket): 1pc.		Nut: 2pcs., Toothed lock washer: 1pc.									

*1: In some countries, flush type is called shielded type.
 *2: Sensing and setting distances are the value to the standard target.
 *3: The weight of threaded type includes nuts and toothed lock washer.

■ SPECIFICATIONS (non-flush type)*1

Classification		Threaded					Square	
Item	Unit No.	GX-8ML	GX-8MLB	GX-12ML	GX-12MLB	GX-18ML	GX-18MLB	GX-18H
Rated sensing distance (*2)		2 mm ± 15%		5 mm ± 10%		10 mm ± 10%		5 mm ± 10%
Setting distance (*2)		0 to 1.6mm		0 to 4mm		0 to 8mm		0 to 4mm
Standard target		Iron plate 12×12×1 mm		Iron plate 15×15×1 mm		Iron plate 30×30×1 mm		Iron plate 24×24×1 mm
Hysteresis		Less than 10% of the rated sensing distance						
Repeat accuracy		Less than 0.04mm			Less than 0.16mm		Less than 0.04mm	
Power source		10 to 30V DC Ripple P-P: Less than 10%						
Consumption		Less than 15mA						
Output		NPN transistor-open collector ● Sink current: Max. 200mA ● Applied voltage: Less than 30V DC ● Residual voltage: Less than 1.5V at 200mA sink current Less than 0.4V at 50mA sink current					NPN transistor-open collector ● Sink current: Max. 100mA at 12V DC Max. 200mA at 24V DC ● Applied voltage: Less than 30V DC ● Residual voltage: Less than 1.5V at 200mA sink current Less than 0.4V at 50mA sink current	
	Output operation	Approach-ON	Leave-ON	Approach-ON	Leave-ON	Approach-ON	Leave-ON	Approach-ON
Short-circuit protection		Included						
Max. response frequency		500Hz		400Hz		200Hz		500Hz
Operation indicator		Red LED (illuminates when output is ON)						
Environmental resistance	Protection	IP 67						
	Ambient temperature	-25 to +70°C / -25 to +80°C (storage)					-25 to +70°C	
	Ambient humidity	35 to 95%RH						
	Noise	Power line: 300Vp, pulse duration 1μs (by noise simulator)						
	Dielectric	500V AC applied between live parts and enclosure for 1 min.						
	Insulation	More than 50MΩ applied between live parts and enclosure at 500V DC						
	Vibration	1.5mm amplitude at frequency of 10 to 55Hz in each of X, Y and Z directions for 2 hours each in power OFF state						
	Shock	300m/s ² (approx. 30G) impulse in each of X, Y and Z directions for 3 times each in power OFF state					300m/s ² (approx. 30G) impulse in each of X, Y and Z directions for 10 times each in power OFF state	
Sensing distance excursion	Temperature	Less than +15% and -10% of sensing distance at 20°C in -25 to +70°C temperature range		Less than ±10% of sensing distance at 20°C in -25 to +70°C temperature range				
	Voltage	Less than ±2.5% at ±15% fluctuation of power source						
Material		Metal parts: Brass (Nickel plated) Plastic parts: 66 nylon		Metal parts: Brass (Nickel plated) Plastic parts: ABS		Metal parts: Brass (Nickel plated) Plastic parts: 6 nylon (with 15% glass)		Green PBT
Cable		0.14mm ² × 3 cores with 3m of oil, heat and cold resistant cable			0.3mm ² × 3 cores with 3m of oil, heat and cold resistant cable		0.3mm ² × 3 cores with 1m of oil, heat and cold resistant cable	
Cable extension		Extensible up to 100m with an equal cable						
Weight (*3)		Approx. 60g		Approx. 70g		Approx. 180g		Approx. 60g
Accessories		Nut: 2pcs., Toothed lock washer: 1pc.						

*1: In some countries, non-flush type is called non-shielded type.

*2: Sensing and setting distances are the values to a target.

*3: The weight of all units except GX-18H includes nuts and toothed lock washer.

INPUT/OUTPUT AND TYPICAL CONNECTION DIAGRAMS

INPUT/OUTPUT Diagrams

GX-5S(B), GX-8M(B), GX-12M(B), GX-18M(B),
GX-30M(B), GX-8ML(B), GX-12ML(B), GX-18ML(B)

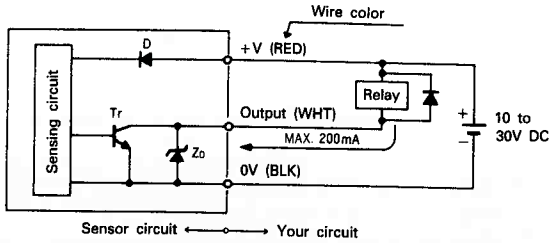

Insert a 100Ω resistor in series as shown in the figure below if a condenser of 1μF or more is connected between the output and 0V or +V.

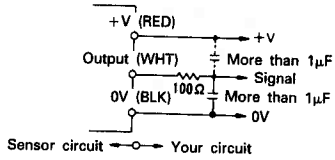

* This is to prevent from delay in response. (though the delay is only instantaneous, it will occur as a result of the actuation of overcurrent protection due to the charge or discharge current of the condenser).

GX-3S(B), GX-5M(B)

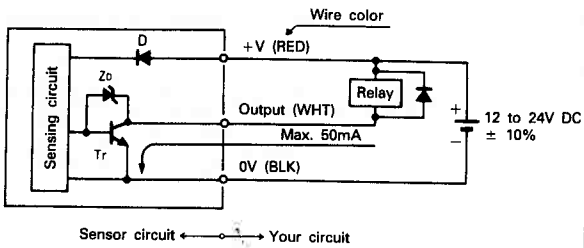

GX-18H

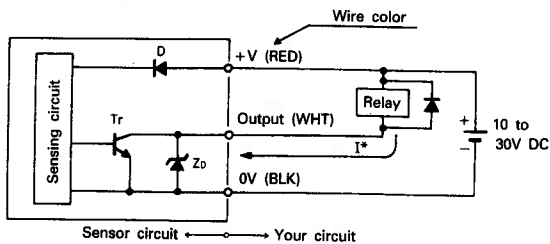

*Sink current: Max. 100mA at power source of 12V DC
Max. 200mA at power source of 24V DC

Where, D: Reverse polarity protection diode
Zd: Surge absorption zener diode
Tr: Output transistor

TYPICAL CONNECTION Diagrams

For current-driven loads (sequencer, counter and photo-coupler)

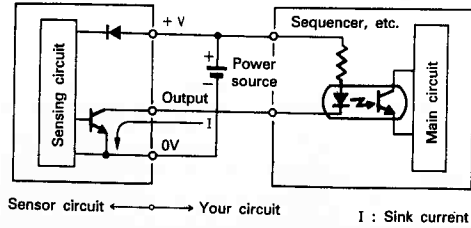

*: Surge absorption zener diode is omitted in the diagram shown above.

For voltage-driven loads (sequencer, counter and logic circuit)

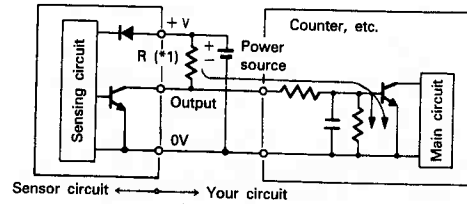

*1: A pull-up resistor "R" is required for above input circuit.
*2: Surge absorption zener diode is omitted in the diagram shown above.

SENSING FIELDS

(These are typical sensing fields, and are subject to slight changes from unit to unit.)

- GX-3S(B)
- GX-5S(B)
- GX-5M(B)
- GX-8M(B)
- GX-12M(B)

• Parallel deviation

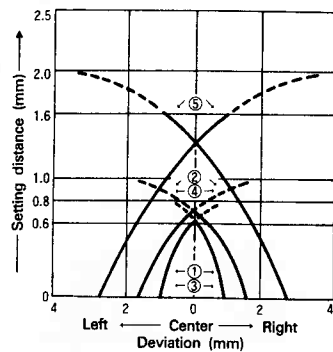

• Target size - Sensing distance correlation

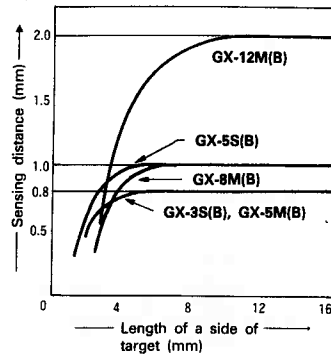

Curve	Unit No.
①	GX-3S(B)
②	GX-5S(B)
③	GX-5M(B)
④	GX-8M(B)
⑤	GX-12M(B)

- GX-18M(B)
- GX-30M(B)
- GX-18H

• Parallel deviation

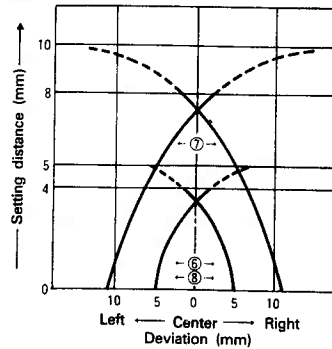

• Target size - Sensing distance correlation

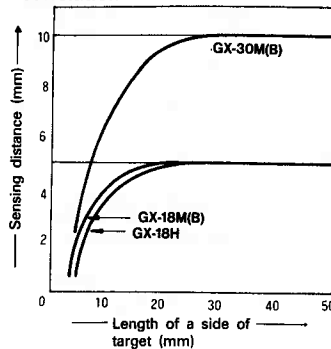

Curve	Unit No.
⑥	GX-18M(B)
⑦	GX-30M(B)
⑧	GX-18H

- GX-8ML(B)
- GX-12ML(B)
- GX-18ML(B)

• Parallel deviation

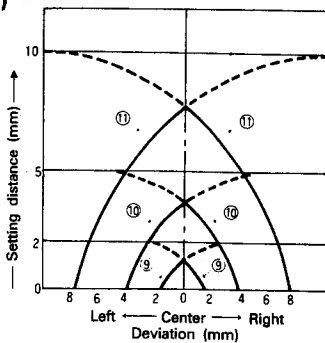

• Target size - Sensing distance correlation

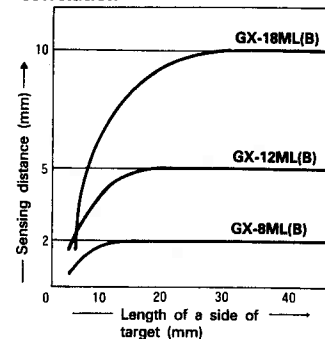

Curve	Unit No.
⑨	GX-8ML(B)
⑩	GX-12ML(B)
⑪	GX-18ML(B)

FOR PROPER USE

● Tightening torque

When mounting, use the torque values listed in the tables below.

Installation with set screw

Threaded and flush type

Do not fix the flat part with too much force. Use a set screw with cut point. For the **GX-5M(B)**, use a M3 or smaller set machine screw.

Set screw (M4 or smaller)

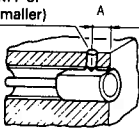

	Range A (mm)	Tightening torque (kgf·cm)
GX-5M(B)	5 to 10	3
GX-8M(B)	8 to 22	3
GX-12M(B)	7 to 24	3
GX-18M(B)	14 to 34	5
GX-30M(B)	14 to 34	7

Unthreaded type and non-flush type

Set machine screw (M4 or smaller)

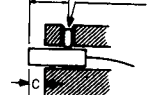

When applying Type C metal fixture, allow a clearance of 3mm or more from the tip of the sensor.

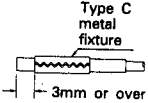

- For the **GX-3S(B)**, use a M3 or smaller set machine screw and tighten it perpendicular to the operation indicator.

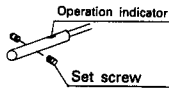

- For the non-flush and threaded type, fix the flat part with a set screw.

Installation with nut

Make sure the tightening torque corresponds to the location of the nut.

(Flush threaded type)

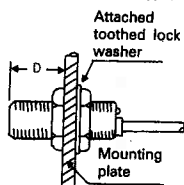

(Non-flush threaded type)

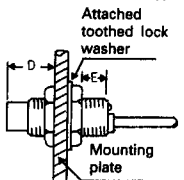

	Length of D	Max. tightening torque
GX-5M(B)	2 to 3mm	5 kgf·cm
	3mm or over	15 kgf·cm
GX-8M(B)	3 to 11mm	15 kgf·cm
	11mm or over	35 kgf·cm
GX-12M(B)	3.5 to 12.5mm	65 kgf·cm
	12.5mm or over	100 kgf·cm
GX-18M(B)	4 to 18mm	150 kgf·cm
	18mm or over	200 kgf·cm
GX-30M(B)	5 to 24mm	500 kgf·cm
	24mm or over	1,600 kgf·cm
GX-8ML(B)	9 to 11mm	10 kgf·cm
	11mm or over	35 kgf·cm
GX-12ML(B)	10.5 to 13.5mm	65 kgf·cm
	13.5mm or over	100 kgf·cm
GX-18ML(B)	14 to 19mm	150 kgf·cm
	19mm or over	200 kgf·cm

*1: Install the sensor so that the nut does not extend past the sensor's threaded portion.

*2: When the length of the E section is 3mm or less on the **GX-12ML(B)**, max. tightening torque should be 65kgf·cm.

● Clearance between sensor and metal around the sensor.

To prevent malfunctions caused by metals around the sensor, pay attention to the following points.

Influence of surrounding metals

The following clearance should be allowed in order to prevent interference by surrounding metals.

Unit No.	F(mm)
GX-3S(B)	3
GX-5S(B)	4
GX-5M(B)	3
GX-8M(B)	4
GX-12M(B)	8
GX-18M(B)	20
GX-30M(B)	40
GX-8ML(B)	8
GX-12ML(B)	20
GX-18ML(B)	40

Unthreaded type and threaded type

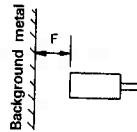

Square type, GX-18H

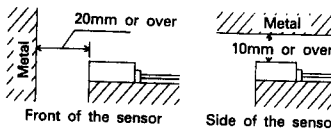

*Clearance should be twice or more than the above when there is metal in front and on both sides of the sensor.

Embedding of the sensor in metal

Sensing distance may be decreased if the sensor is completely embedded in metal. Especially, for the unthreaded type and the non-flush type (unit with "ML"), establish the following values for H and G.

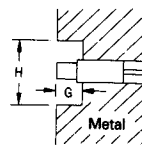

Unit No.	G(mm)	H(mm)
GX-3S(B)	3	φ12
GX-5S(B)	5	φ15.4
GX-8ML(B)	10	φ30
GX-12ML(B)	15	φ40
GX-18ML(B)	22	φ55

● Mutual interference

When mounting plural inductive proximity sensors parallel or face to face, allow a clearance listed in the table below to avoid mutual interference.

Face to face mounting

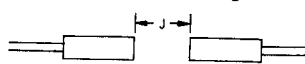

Parallel mounting

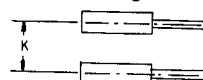

Unit No.	J(mm)	K(mm)
GX-3S(B)	16	16
GX-5S(B)	20	15
GX-5M(B)	10	10
GX-8M(B)	20	15
GX-12M(B)	30	20
GX-18M(B)	50	35
GX-30M(B)	100	70
GX-8ML(B)	50	30
GX-12ML(B)	90	60
GX-18ML(B)	200	110
GX-18H	140	80

*If the sensors are of different units, apply the greater clearance.

● Head cover

The head cover keeps the sensing face of the inductive proximity sensor away from flash sputter.

(Mounting method)

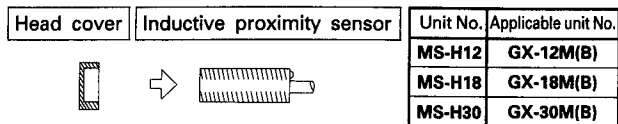

Material: Fluorine resin

*Attach the head cover correctly without any space between the head cover and the sensing face of the sensor.

● Sensing distance

The sensing distance listed in the specifications is for the SUNX standard target. For non-ferrous object detection, the sensing distance is obtained by multiplying the correction coefficient in the table below.

● Correction coefficient

Unit No. / Target	GX-3S(B)	GX-5M(B)	All units except GX-3S/5M
Iron	Approx. 1.0	Approx. 1.0	Approx. 1.0
Stainless (SUS304)	Approx. 0.65	Approx. 0.83	Approx. 0.7
Brass	Approx. 0.36	Approx. 0.61	Approx. 0.4
Aluminum	Approx. 0.30	Approx. 0.58	Approx. 0.35

*Be careful that the sensing distance varies in case the target is plated.

- If a switching regulator is used for the power source of the sensor, be sure to ground the frame ground (F.G.) terminal to an actual ground.
- Do not use the sensor output signal for 10ms immediately after power is supplied to the sensor.
- Avoid mis-wiring (outputs of **GX-3S(B)**, **GX-5M(B)** and **GX-18H** do not have a short-circuit protection.)
- Do not run sensor cables near high-voltage lines or power lines, nor put them together in the same raceway. This warning should be strictly observed to prevent malfunctions caused by inductive interference.
- Avoid placement where the sensor will be exposed to chemical agents like organic solvents.
- Metal dust covering the sensing surface will cause a malfunction.

■ DIMENSIONS (mm)

- GX-3S
- GX-3SB

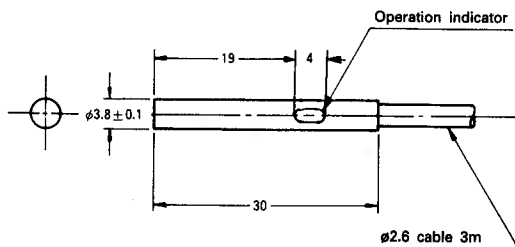

- GX-5S
- GX-5SB

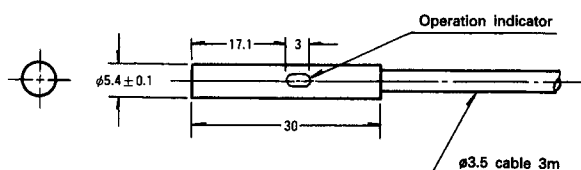

(mm)

- GX-5M
- GX-5MB

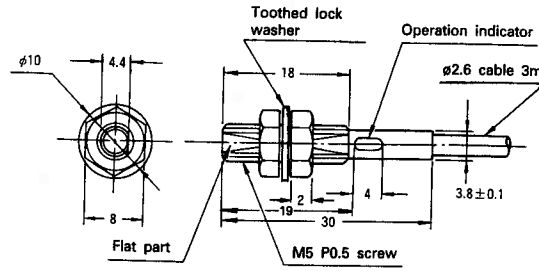

- GX-8M
- GX-8MB

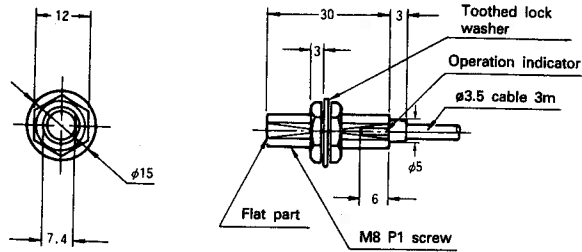

- GX-12M
- GX-12MB

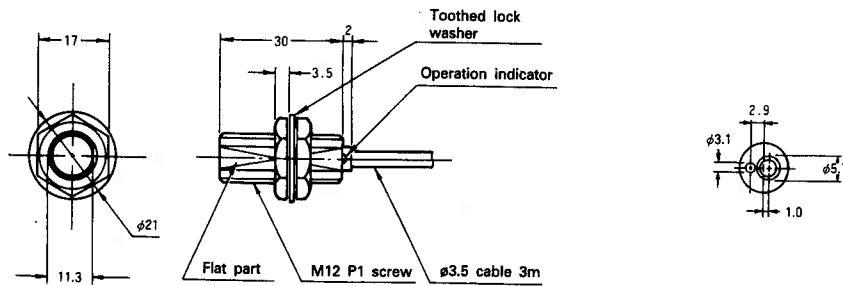

- GX-18M
- GX-18MB

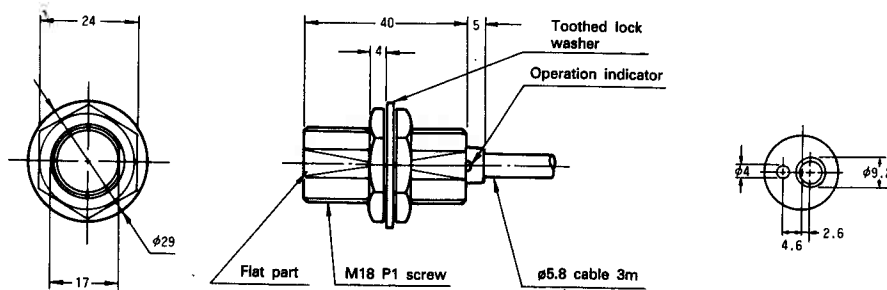

- GX-30M
- GX-30MB

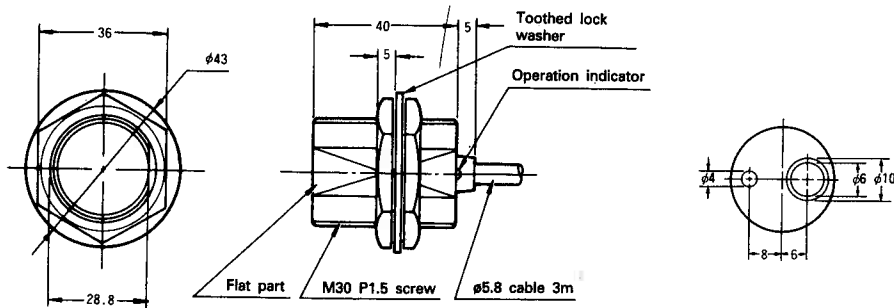

- GX-8ML
- GX-8MLB

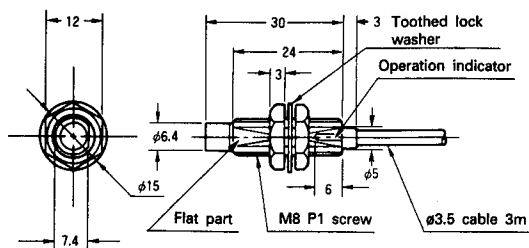

- GX-12ML
- GX-12MLB

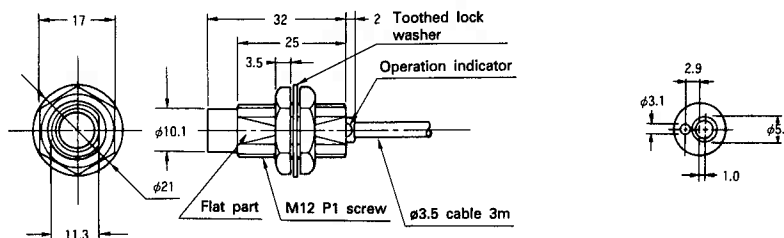

- GX-18ML
- GX-18MLB

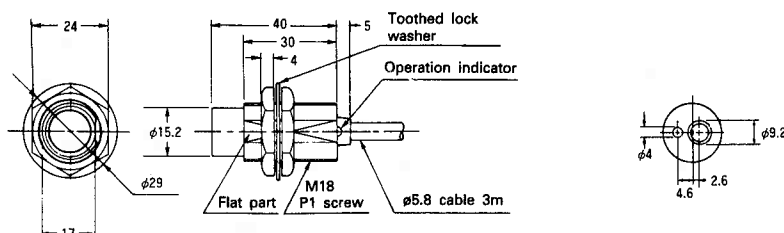

- GX-18H

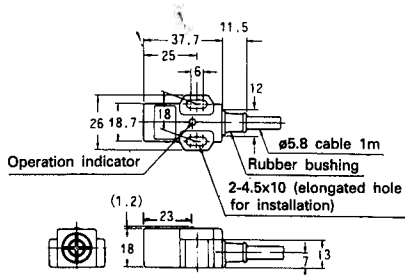

Head cover (optional)

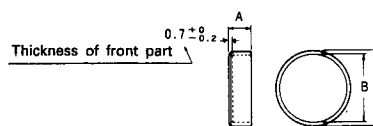

Unit No.	Mark	A	B	C	Applicable unit No.
MS-H12	5	φ11.5	φ14		GX-12M(B)
MS-H18	6	φ17.5	φ20		GX-18M(B)
MS-H30	8	φ29.4	φ33		GX-30M(B)

- MS-SS3-2

By using this bracket, the sensor enclosure accepts twice as strong tightening torque as normal torque.

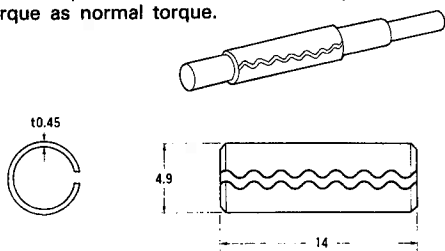

- MS-SS3
- MS-SS5

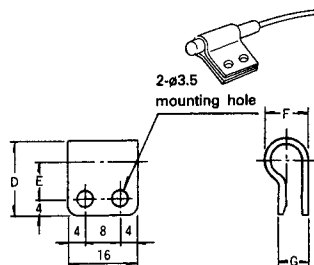

Unit No.	Mark	
	MS-SS3	MS-SS5
D	16	18
E	9	10
F	6.3	8.3
G	4.9	6.1
Applicable unit No.	GX-3S(B)	GX-5S(B)

• Material: 66 nylon