

Pressure sensor Built-in amplifier and compensating circuit

PS-A PRESSURE SENSOR



S Package



M Package



L Package

New



P Package

RoHS compliant

FEATURES

1. Contains built-in amplification and temperature compensation circuit. Circuit design and adjustment of characteristics are not required by users.

2. High-level precision and high reliability realized.

- Overall accuracy is $\pm 1.25\%$ FS (Standard type)

- Overall accuracy is $\pm 4\%$ FS (Economy type)

- Overall accuracy is $\pm 2.5\%$ FS (Low pressure type)

3. Compact pressure sensor unit that saves space.

Same size and as previous PS pressure sensor. (Standard/Economy type, S and M Packages)

TYPICAL APPLICATIONS

(Please evaluate under actual conditions before using.)

- **Industrial use:** pressure switches and pneumatic devices, etc.

- **Medical use:** blood pressure monitors, compressed air pressure measurement, air beds, etc.

- **Other pneumatically operated pressure devices**

Low pressure type

1. Water level detection for household appliances

Washing machines and dishwashers.

2. Medical applications

Respiratory pressure measuring instrument, etc.

ORDERING INFORMATION

ADP5 1

<Terminal profile>
1: DIP terminal



<Rated pressure>

- 0: ± 100 kPa
- 1: -100 kPa
- 2: 25 kPa
- 3: 50 kPa
- 4: 100 kPa
- 5: 200 kPa
- 6: 500 kPa
- 7: 1,000 kPa
- A: 40 kPa
- B6: 6 kPa (Low pressure type)

<Package/Pressure inlet hole>

- 0: S Package
length: 3 mm .118 inch, diameter: 3 mm .118 inch
- 1: M Package
length: 5 mm .197 inch, diameter: 3 mm .118 inch
- 2: L Package (Only low pressure type)
length: 13.5 mm .531 inch, diameter: 5.45 mm .215 inch
- 3: P Package (Only low pressure type)
length: 15.6 mm .614 inch, diameter: 5.45 mm .215 inch

<Base type>

- Nil: With glass base (Standard type/Low pressure type)
- 1: Without glass base (Economy type)

Note: Some part numbers may not be available depending on the combination. Please refer to the Table of PRODUCT TYPES on the next page.

PRODUCT TYPES

Pressure		Part No.				
		Standard type	Standard/Economy type	Low pressure type		
		S Package (3mm .118inch)	M Package (5mm .197inch)	M Package (5mm .197inch)	L Package (13.5mm .531inch)	P Package (15.6mm .614inch)
Terminal	DIP terminal 					
Standard type (with glass base)	±100kPa	ADP5100	ADP5101	—	—	—
	-100kPa	ADP5110	ADP5111	—	—	—
	25kPa	ADP5120	ADP5121	—	—	—
	50kPa	ADP5130	ADP5131	—	—	—
	100kPa	ADP5140	ADP5141	—	—	—
	200kPa	ADP5150	ADP5151	—	—	—
	500kPa	ADP5160	ADP5161	—	—	—
Economy type (without glass base)	40kPa	—	ADP51A11	—	—	—
Low pressure type	6kPa	—	—	ADP51B61	ADP51B62	ADP51B63

Standard packing: Carton: 100 pcs.; Case: 1,000 pcs.

RATING

1. Standard type

Item		Standard type (with glass base)								Remarks	
Type of pressure		Gauge pressure									
Pressure medium		Air								Note*1	
Rated pressure	Unit: kPa	±100	-100	25	50	100	200	500	1,000		
Max. applied pressure		Twice the rated pressure								1.5 times the rated pressure	
Drive voltage		5±0.25V DC									
Temperature compensation range		0 to 50°C 32 to 122°F									
Offset voltage		2.5±0.05V	0.5±0.05V							Note*2,3	
Rated output voltage		4.5±0.05V (when +100kPa)	4.5±0.05V							Note*2,3	
Overall accuracy		±1.25%FS								Note*3 Note*4	
Current consumption		Max. 10mA								Note*2,3	
Output impedance		15Ω (Typical)								Note*2	
Source current		Max. 0.2mA								Note*2,3	
Sink current		Max. 2mA								Note*2,3	

Notes: 1. Please consult us for pressure media other than air.

2. Indicates output when temperature is 25°C 77°F.

3. Indicates output when drive voltage is 5 V. Although output fluctuates due to fluctuations in the drive voltage, this is not included.

4. Overall accuracy indicates the accuracy of the offset voltage and rated output voltage at a temperature compensation range of 0 to 50°C 32 to 122°F.

2. Economy type

Item		Economy type (without glass base)								Remarks
Type of pressure		Gauge pressure								
Pressure medium		Air								Note*1
Rated pressure	Unit: kPa	40								
Max. applied pressure		Twice the rated pressure								
Drive voltage		3±0.15V DC								
Temperature compensation range		5 to 45°C 41 to 113°F								
Offset voltage		0.3±0.09V								Note*2,3
Span voltage		2.4±0.03V								Note*2,3
Offset voltage temperature characteristics		±4.0%FS								Note*3,4
Sensitivity temperature characteristics		1.3%FS								Note*3,4
Current consumption		Max. 3mA								Note*2
Output impedance		20Ω (Typical)								Note*2,3
Source current		Max. 0.15mA								Note*2,3
Sink current		Max. 1.5mA								Note*2,3

Notes: 1. Please consult us for pressure media other than air.

2. Indicates output when temperature is 25°C 77°F.

3. Indicates output when drive voltage is 3 V. Although output fluctuates due to fluctuations in the drive voltage, this is not included.

4. Indicates from output value at 25°C 77°F and the change of output at 5 and 45°C 41 to 113°F.

3. Low pressure type

Item	Low pressure type	Remarks
Type of pressure	Gauge pressure	
Pressure medium	Air	Note*1
Rated pressure	6	
Unit: kPa		
Max. applied pressure	Twice the rated pressure	
Drive voltage	5±0.25V DC	
Temperature compensation range	0 to 70°C 32 to 158°F	
Offset voltage	0.5V (Typical)	Note*2
Span voltage	4.0V (Typical)	Note*2
Overall accuracy	±2.5%FS	Note*2, 3, 4
Current consumption	Max. 10mA	
Output impedance	15Ω (Typical)	
Source current	Max. 0.2mA	
Sink current	Max. 2.0mA	

Notes: 1. Please consult us for pressure media other than air.
 2. Indicates output when drive voltage is 5 V. Although output fluctuates due to fluctuations in the drive voltage, this is not included.
 3. Overall accuracy indicates the accuracy of the offset voltage and span voltage at temperatures between 0 to 70°C 32 to 158°F (FS=4V)
 4. The initial offset voltage error is not included in the overall accuracy.

* Items where no temperature is listed are specifications at 25°C 77°F.

REFERENCE DATA

1. Standard type

1.-(1) Output voltage

ADP5170
 Drive voltage: 5V DC
 Temperature: 25°C 77°F
 Applied pressure: 0 to +1,000kPa

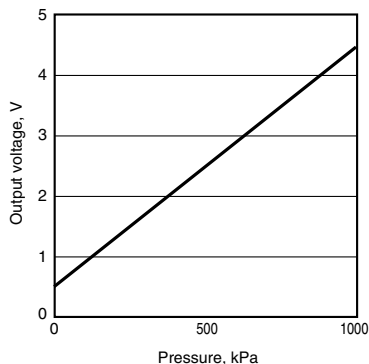

1.-(2) Overall accuracy (Offset voltage)

ADP5170
 Drive voltage: 5V DC
 Temperature: 0 to 50°C 32 to 122°F
 Applied pressure: 0kPa

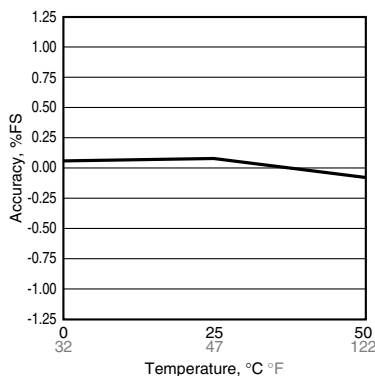

1.-(3) Overall accuracy (Rated output voltage)

ADP5170
 Drive voltage: 5V DC
 Temperature: 0 to 50°C 32 to 122°F
 Applied pressure: +1,000kPa

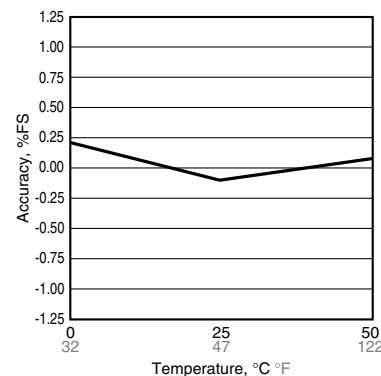

2.-(1) Output voltage

ADP5100
 Drive voltage: 5V DC
 Temperature: 25°C 77°F
 Applied pressure: -100 to +100kPa

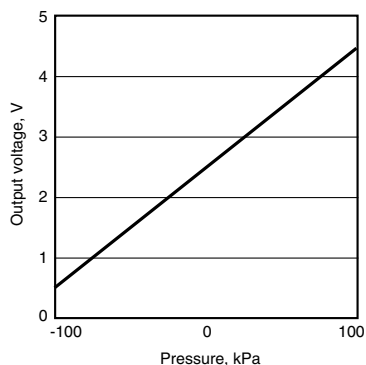

2.-(2) Overall accuracy (Offset voltage)

ADP5100
 Drive voltage: 5V DC
 Temperature: 0 to 50°C 32 to 122°F
 Applied pressure: 0kPa

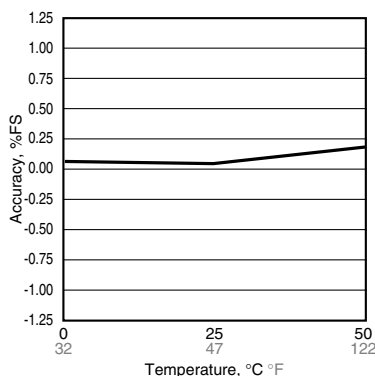

2.-(3) Overall accuracy (Rated output voltage)

ADP5100
 Drive voltage: 5V DC
 Temperature: 0 to 50°C 32 to 122°F
 Applied pressure: +100kPa

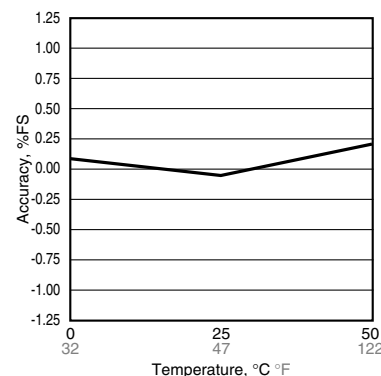

PS-A (ADP5)

2. Low pressure type

1. Output voltage

ADP51B61
 Drive voltage: 5V
 Temperature: 25°C 77°F
 Applied pressure: 0 to 6kPa

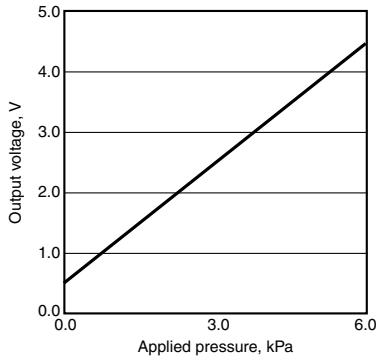

2. THB (high temperature high humidity bias test)

ADP51B61
 Within 85°C 185°F and 85% RH
 5 V applied between No. 2 (Vdd) and No. 3 (GND)
 Applied pressure: 0kPa

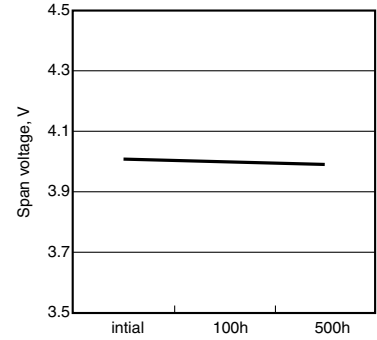
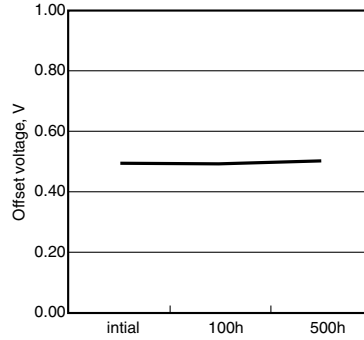

3. Ambient temperature characteristics

Ambient temperature: 25°C 77°F → 0°C 32°F → 10°C 50°F → 60°C 140°F → 70°C 158°F

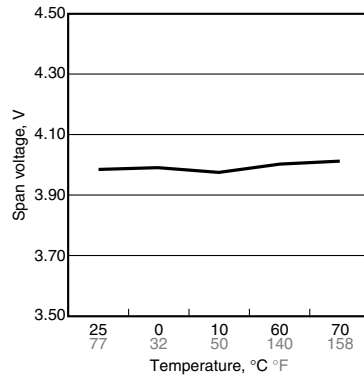
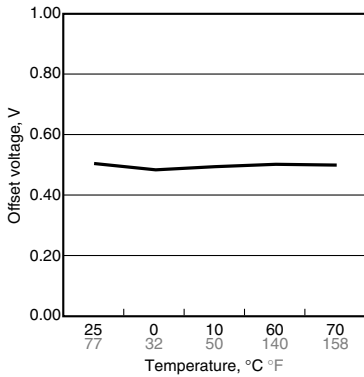

4. Shock test

ADP51B61
 Shock applied: 981 m/s², 3 times in x, y and z directions
 Applied pressure: 0kPa

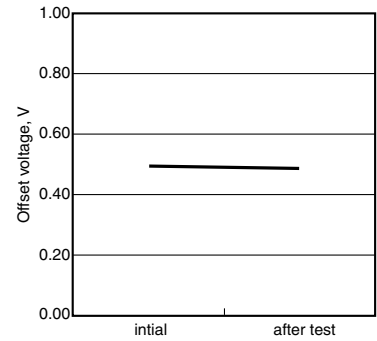

5. Vibration test

ADP51B61
 Vibration applied: 10 to 55 Hz, amplitude: 1.5mm .059inch, x, y and z directions, 2 hrs each
 Applied pressure: 0kPa

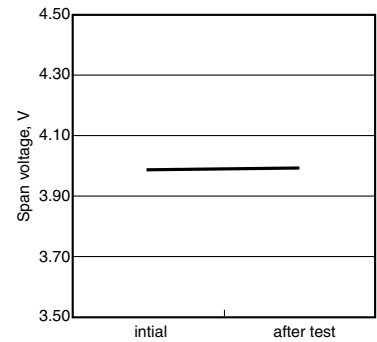
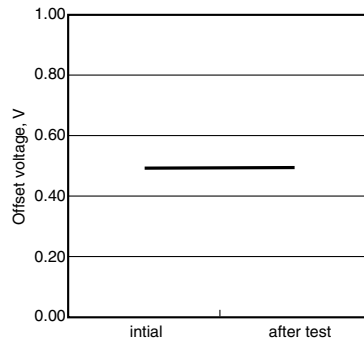
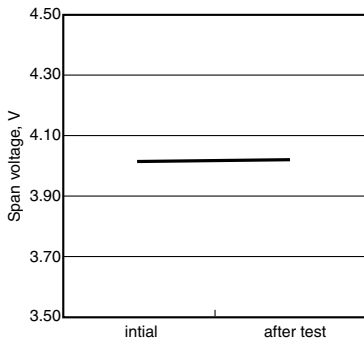

6. Temperature/humidity cycle test

ADP51B61
 Exposed to 10 cycles in the temperature and humidity conditions given below.
 Applied pressure: 0kPa

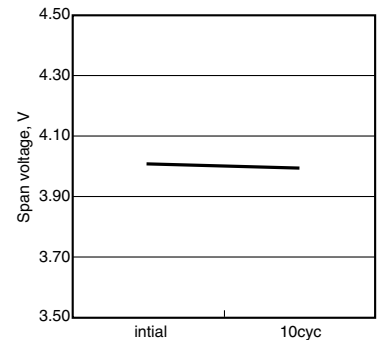
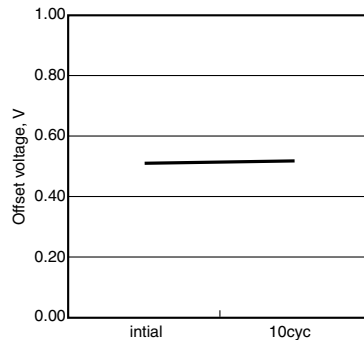
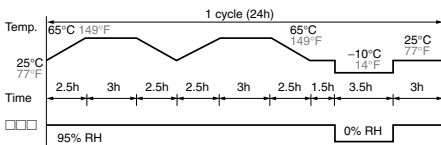

3. Evaluation test

Classification	Tested item	Tested condition	Result
Environmental characteristics	Storage at high temperature	Temperature: Left in a 85°C 185°F constant temperature bath; Time: 100 hrs.	Passed
	Storage at low temperature	Temperature: Left in a -20°C -4°F constant temperature bath; Time: 100 hrs.	Passed
	Humidity resistance	Temperature/humidity: Left at 40°C 104°F, 90% RH; Time: 100 hrs.	Passed
	Temperature cycle	Temperature: -20°C to 85°C -4°F to 185°F; 1 cycle: 30 min.; Times of cycle: 100	Passed
Endurance characteristics	High temperature/high humidity operation	Temperature/humidity: 40°C 104°F, 90% RH; Operation times: 10 ⁶ , rated voltage applied	Passed
Mechanical characteristics	Vibration resistance	Double amplitude: 1.5 mm .059 inch; Vibration: 10 to 55 Hz; Applied vibration direction: X, Y, Z 3 directions; Times: 2 hrs each	Passed
	Dropping resistance	Dropping height: 75 cm 29.528 inch; Times: 2 times	Passed
	Terminal strength	Pulling strength: 9.8 N {1 kgf}, 10 sec.; Bending strength: 4.9 N {0.5 kgf}, left and right 90° 1 time	Passed
Soldering resistance	Soldered in DIP soldering bath	Temperature: 230°C 446°F; Time: 5 sec.	Passed
	Temperature (DIP)	Temperature: 260°C 500°F; Time: 10 sec.	Passed

DIMENSIONS (mm inch)

The CAD data of the products with a **CAD Data** mark can be downloaded from: <http://industrial.panasonic.com/ac/e/>

1. Standard type S Package (Pressure inlet hole length: 3mm .118inch)

General tolerance: ±0.3 ±.012

ADP51*0

CAD Data

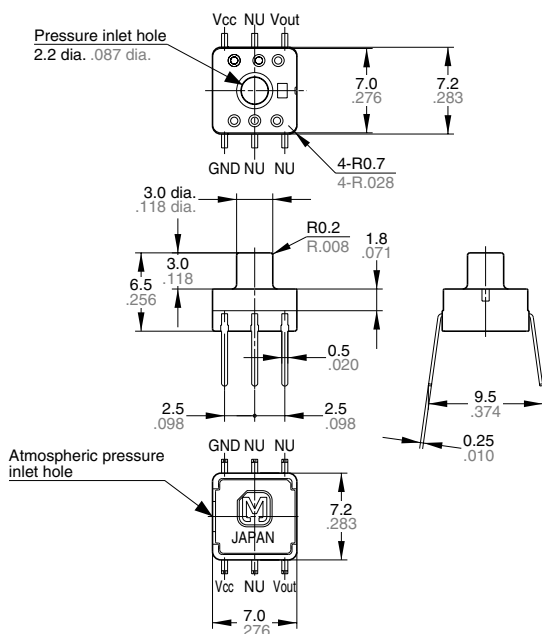

Recommended PC board pattern

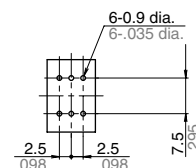

Terminal connection diagram

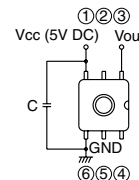

Terminal No.	Name
1	Vcc (Power supply [+])
2	NU (Not usable)
3	Vout (Output)
4	NU (Not usable)
5	NU (Not usable)
6	GND (Ground)

2. Standard/Economy type M Package (Pressure inlet hole length: 5mm .197inch)

ADP51*1/ADP51A11

CAD Data

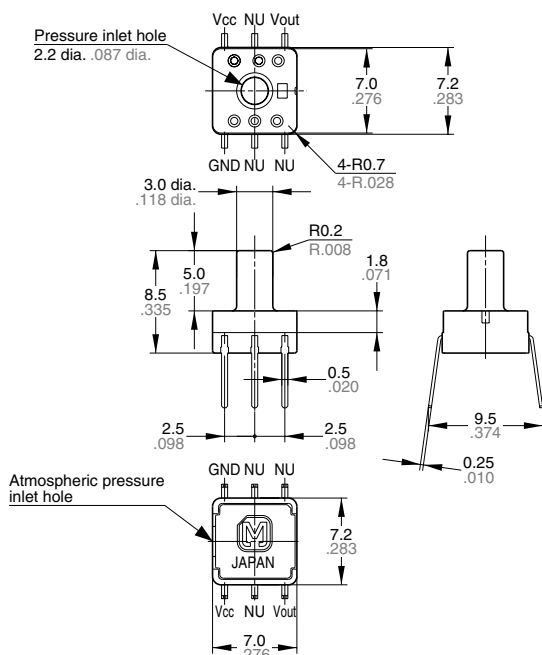

Recommended PC board pattern

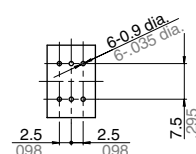

Terminal connection diagram

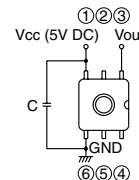

Terminal No.	Name
1	Vcc (Power supply [+])
2	NU (Not usable)
3	Vout (Output)
4	NU (Not usable)
5	NU (Not usable)
6	GND (Ground)

PS-A (ADP5)

3. Low pressure type M Package (Pressure inlet hole length: 5mm .197inch) ADP51B61

General tolerance: $\pm 0.3 \pm 0.12$

CAD Data

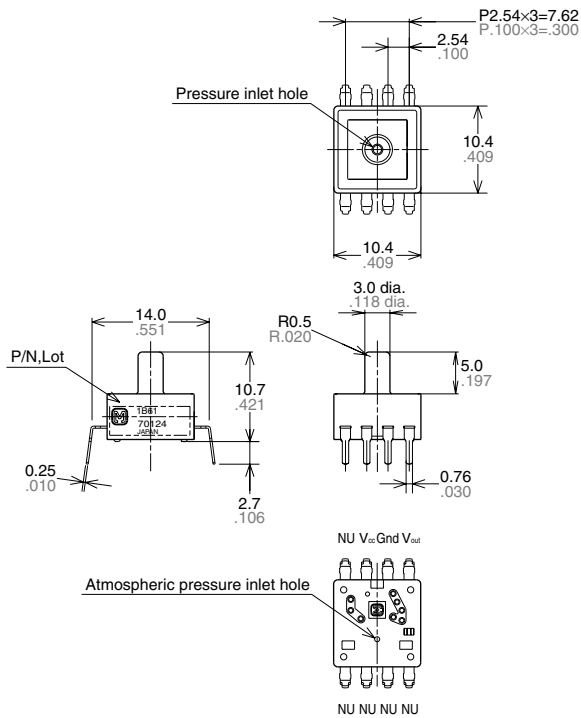

Recommended PC board pattern

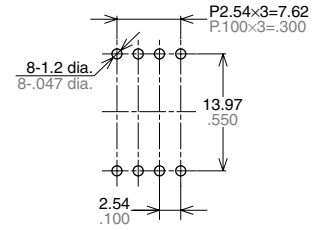

Terminal connection diagram

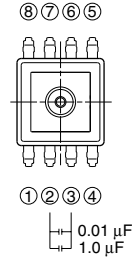

Terminal No.	Name
1	NU (Not usable)
2	V _{cc} (Power supply [+])
3	GND (Ground)
4	V _{out} (Output)
5	NU (Not usable)
6	NU (Not usable)
7	NU (Not usable)
8	NU (Not usable)

4. Low pressure type L Package (Pressure inlet hole length: 13.5mm .531inch) ADP51B62

CAD Data

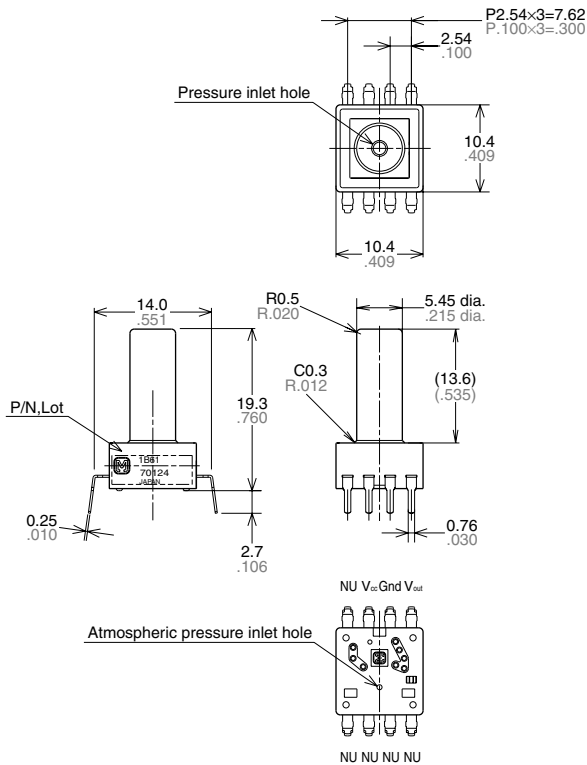

Recommended PC board pattern

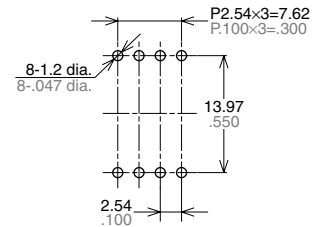

Terminal connection diagram

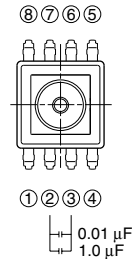

Terminal No.	Name
1	NU (Not usable)
2	V _{cc} (Power supply [+])
3	GND (Ground)
4	V _{out} (Output)
5	NU (Not usable)
6	NU (Not usable)
7	NU (Not usable)
8	NU (Not usable)

5. Low pressure type P Package (Pressure inlet hole length: 15.6mm .614inch)

ADP51B63

General tolerance: $\pm 0.3 \pm 0.12$

Recommended PC board pattern

CAD Data

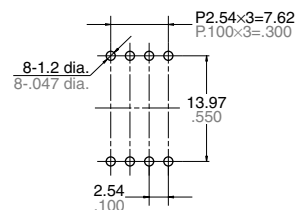
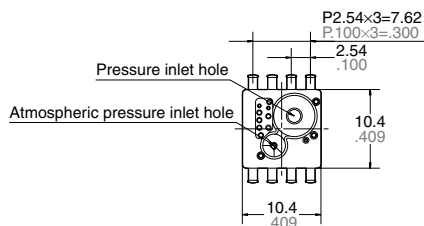

Terminal connection diagram

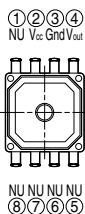
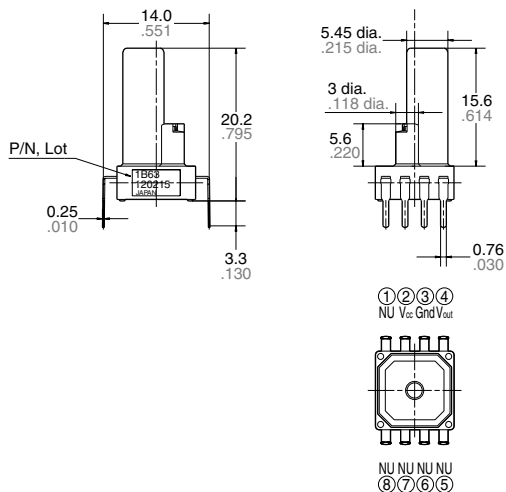
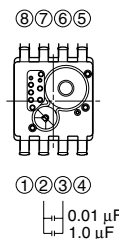

Terminal No.	Name
1	NU (Not usable)
2	Vcc (Power supply [+])
3	GND (Ground)
4	Vout (Output)
5	NU (Not usable)
6	NU (Not usable)
7	NU (Not usable)
8	NU (Not usable)

NOTES

1. Mounting

Use lands on the printed-circuit boards to which the sensor can be securely fixed.

2. Soldering

Due to its small size, the thermal capacity of the pressure sensor DIP type is low. Therefore, take steps to minimize the effects of external heat.

Damage and changes to characteristics may occur due to heat deformation.

Use a non-corrosive resin type of flux.

Since the pressure sensor DIP type is exposed to the atmosphere, do not allow flux to enter inside.

1) Manual soldering

- Set the soldering tip from 260 to 300°C 500 to 572°F (30W), and solder for no more than 5 seconds.

- Please note that output may change if the pressure is applied on the terminals when the soldering.

- Thoroughly clean the soldering iron.

2) DIP soldering (DIP terminal type)

- Please keep the DIP solder bath temperature no higher than 260°C 500°F. When soldering, heat should be applied no longer than five seconds.

- When mounting onto a PCB of low thermal capacity, please avoid DIP soldering as this may cause heat deformity.

3) Solder reworking

- Finish reworking in one operation.

- For reworking of the solder bridge, use a soldering iron with a flat tip. Please do not add more flux when reworking.

- Please use a soldering iron that is below the temperature given in the specifications in order to maintain the correct temperature at the tip of the soldering iron.

4) Too much force on the terminals will cause deformation and loss in effectiveness of the solder. Therefore, please avoid dropping and careless handling of the product.

5) Please control warping of the PCB within 0.05 mm of the sensor width.

6) When cut folding the PCB after mounting the sensor, take measures to prevent stress to the soldered parts.

7) The sensor terminals are designed to be exposed, so contact of the terminals with metal shards and the like will cause output errors. Therefore, please be careful and prevent things such as metal shards and hands from contacting the terminals.

8) To prevent degradation of the PCB insulation after soldering, please be careful not to get chemicals on the sensor when coating.

9) Please consult us regarding the use of lead-free solder.

3. Connections

1) Please perform connections correctly in accordance with the terminal connection diagram. In particular, be careful not to reverse wire the power supply as this will cause damage or degrade to the product.

2) Do not connect terminals that are not used. This can cause malfunction of the sensor.

4. Cleaning

1) Since the pressure sensor chip is exposed to the atmosphere, do not allow cleaning fluid to enter inside.

2) Avoid ultrasonic cleaning since this may cause breaks or disconnections in the wiring.

5. Environment

1) Please avoid using or storing the pressure sensor chip in a place exposed to corrosive gases (such as the gases given off by organic solvents, sulfuric acid gas, hydrogen sulfides, etc.) which will adversely affect the performance of the pressure sensor chip.

2) To ensure resistance to power supply superimposed noise, you must provide a capacitor at the power supply input terminal of the sensor in order to stabilize the power supply voltage. We recommend to provide 0.1 μF and 1,000 pF capacitor in parallel. Please confirm the noise resistance with the actual equipment and choose adequate capacitor.

3) Since the internal circuitry may be destroyed if an external surge voltages is supplied, provide an element which will absorb the surges.

4) Malfunctioning may occur if the product is in the vicinity of electrical noise such as that from static electricity, lightning, a broadcasting station, an amateur radio, or a mobile phone.

5) Since this pressure sensor chip does not have a water-proof construction, please do not use the sensor in a location where it may be sprayed with water, etc.

6) Avoid using the pressure sensors chip in an environment where condensation may form.

Furthermore, its output may fluctuate if any moisture adhering to it freezes.

7) The pressure sensor chip is constructed in such a way that its output will fluctuate when it is exposed to light. Especially when pressure is to be applied by means of a transparent tube, take steps to prevent the pressure sensor chip from being exposed to light.

8) Avoid using the pressure sensor chip where it will be susceptible to ultrasonic or other high-frequency vibration.

6. Quality check under actual loading conditions

To assure reliability, check the sensor under actual loading conditions. Avoid any situation that may adversely affect its performance.

7. Other handling precautions

1) That using the wrong pressure range or mounting method may result in accidents.

2) The only direct pressure medium you can use is dry air. The use of other media, in particular, corrosive gases (organic solvent based gases, sulfuric acid based gases, and hydrogen sulfide based gases, etc.) and media that contains moisture or foreign substances will cause malfunction and damage. Please do not use them.

3) The pressure sensor chip is positioned inside the pressure inlet hole. Never poke wires or other foreign matter through the pressure inlet hole since they may damage the chip or block the inlet hole. Avoid use when the atmospheric pressure inlet is blocked.

4) Use an operating pressure which is within the rated pressure range. Using a pressure beyond this range may cause damage.

5) Since static charge can damage the pressure sensor chip, bear in mind the following handling precautions.

(1) When storing the pressure sensor chips, use a conductive material to short the pins or wrap the entire chip in aluminum foil. Plastic containers should not be used to store or transport the chips since they readily become charged.

(2) When using the pressure sensor chips, all the charged articles on the bench surface and the work personnel should be grounded so that any ambient static will be safely discharged.

6) Based on the pressure involved, give due consideration to the securing of the pressure sensor DIP type and to the securing and selection of the inlet tube. Consult us if you have any queries.

7) When coating a PC board after mounting the pressure sensor, be sure to prevent the material from entering the pressure inlet hole or atmospheric pressure inlet hole. Use an elastic resin for coating to avoid expansion and contraction due to heat, which apply stress to the sensor.

Please carefully examine the usability.